

1. 产品介绍 (Product introduction)

AUPO 温度保险丝是一种不可复位型热敏保护器件，用于家用电器及工业设备的过热保护，当周围温度升高到某不正常温度时，温度保险丝感受外界温度状态，将电路切断。它的全密封结构确保其熔断系统稳定可靠，不受外界潮湿等恶劣环境影响。它的主要特点是：对外界温度感受灵敏；动作温度准确、稳定；体积小，密封式结构；性能可靠，已获多个国际安全标准认证。

AUPO thermal cutoffs is a Non-resettable part for temperature protection, it is used in household electric appliances and industrial equipment for temperature protection: When ambient rises to an abnormal temperature, the thermal cutoffs sensors ambient temperature and function to break the circuit. sealed structure of thermal cutoffs insures the function system's stability and reliability, and avoid influencing by ambient humidity etc. thermal cutoffs characters are: Extremely sensitive to ambient temperature; Precise and Stable for functioning temperature; Small size, Sealed structure; Reliable, Certifications by various international safety standards.

2. 外观和外形尺寸 (Dimensions)

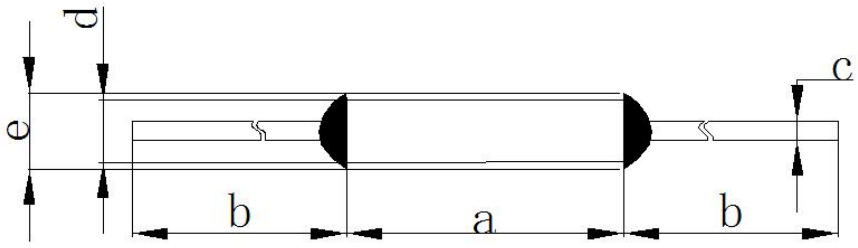

尺寸(mm)

Model No	Product No	a	b	c	d	e
P*-5A-F	P*-5A-F	11.5 ± 0.5	38 ± 3	Φ0.6 ± 0.05	Φ3.3 ± 0.2	3.6 or below

3.型号及主要技术参数 (Technical parameters)

产品型号: Model No:	产品料号: Product No:	额定动作温度 Tf(°C)	实测动作温度 Fusing-off Temp		保持温度 Th(°C)			极限温度 Tm(°C)			额定电流 Ir(A)	额定电压 Ur(Vac)
			Corp Standard 企标	IEC Standard IEC 标准	UL	CCC	VDE	UL	CCC	VDE		
P0-5A-F	P0-5A-F	84	80-84	74-84	65	65	60	180	200	200	5	250
P1-5A-F	P1-5A-F	102	96-100	92-102	80	80	76	180	200	200	5	250
P2-5A-F	P2-5A-F	115	109-115	105-115	95	95	95	180	200	200	5	250
P3-5A-F	P3-5A-F	125	117-123	115-125	105	105	105	180	200	200	5	250
P4-5A-F	P4-5A-F	130	124-128	120-130	107	107	107	180	200	200	5	250
P5-5A-F	P5-5A-F	135	128-134	125-135	115	115	115	180	200	200	5	250
P9-5A-F	P9-5A-F	138	133-137	128-138	115	115	111	180	200	200	5	250
P12-5A-F	P12-5A-F	145	138-142	135-145	N	126	122	N	200	200	5	250
P7-5A-F	P7-5A-F	150	142-148	140-150	128	128	124	180	200	200	5	250

4. 产品结构说明 (Structural instruction)

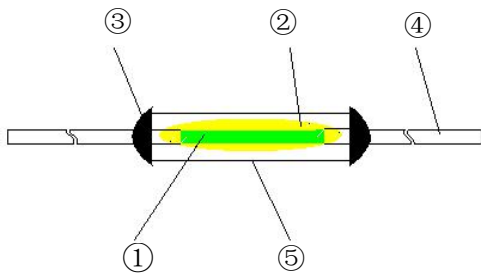

- ①易熔合金 Thermal alloy
- ②特殊树脂 Special resin compound
- ③环氧树脂 Epoxy
- ④镀锡铜线 Lead wire
- ⑤外壳 Case

5.最终检验 (Final inspection)

检验项目 Inspection items	样本量 sample qty	检验工具 Inspection tools	检验标准 Inspection standard	允收标准 Acceptance standard	检验方法 Test method
导电 electric conduction	全数检验 Full inspect	导电测试台 Conducting test bench	产品能导通且电阻值不超过规定的上限值 The product is conductive but resistance not exceed the upper limit.	C=0	用相应的比对电阻调整导电测试台后,逐一测试 Adjust conducting test bench with corresponding contrast resistance and test one by one.

动作温度 (Tf)	N	硅油池 Silicone oil bath	均应在相应产品的 动作温度规格范围 内 All should be within the specified Tf temp. Of corresponding products	C=0	将产品放入硅油池中,在起始 温度(为额定动作温度-12K) 恒温 5 分钟后,以 0.5K/min - 1K/min 的速率升温,记录产品 熔断时的温度,检测电流在 10mA 以下 TCO is tested in the oil bath of which the starting temperature (Tf minus 12K) maintains 5 minutes and the temperature rises at 0.5K/min-1K/min (testing current less than 10mA).Record down the temperature when TCO fuses off.
耐压 (两极间) Voltage withstand (between two poles)	N	高压机 High pressure machine	不得有击穿现象 No breakdown phenomenon	C=0	测试熔断后的产品,在二引脚 之间施加 500VAC 电压 1min (漏电流:2mA) After testing fusing-off products, 500VAC voltage is applied to between the two pins for 1 min(leakage current:2mA)
耐压 (极与壳 之间) Voltage withstand (between pole and shell)	1/5 N	高压机 High pressure machine	不得有击穿现象 No breakdown phenomenon	C=0	将外壳套入适宜的铜套内作 为一极;两引脚作为另一极,在 两极间施加 1500VAC 电压 1min(漏电流:2mA) Apply 1500VAC voltage for 1min to between housing afterinserted with brass shell and 2-lead as a pole (leakagecurrent: 2mA)
绝缘性 Insulating property	N	绝缘电阻表 Insulation resistance meter	应 $\geq 0.2M\Omega$	C=0	将测试熔断后的产品,用绝缘 电阻表测量两极间绝缘电阻 (500VDC) Test the insulation resistance (500DCV) of the two electrodes with insulation resistance meter.
耐扭转试验 Torsion resistance test	1/5 N	目视 Visual inspection	环氧树脂无脆裂且 引脚无断裂现象 Epoxy resin no brittle crack and no fracture of lead	C=0	取未经测试的成品,用手拿住 引脚在距离引脚根部约 10mm 处折成直角后(避免引 脚根部受力),以根部部分的引 脚为轴来回扭转 180° x1time Prepare not-tested goods, hold the lead at 10mm distance from its root and bend into 90°(avoid stress on the root of the lead), 180°back and forth torsion for once based on lead of root.
抗拉力测试 Tensile test	1/5 N	拉力测试器、 砝码 Tension tester, balancing weight	环氧树脂无脆裂且 引脚无断裂现象 Epoxy resin no brittle crack and no fracture of lead	C=0	取未经测试的成品,固定产品 一端引脚,另一引脚吊拉 1.5 lbs 重物 1min Prepare not-tested goods, fix the pin at one end of the product and pull 1.5 lbs weight at the other end for 1min.

备注: N:若批量小于等于 1200pcs, 抽取 10pcs; 1201 ~ 3200pcs 抽取 15pcs, 3201 ~ 20000 pcs 抽取 20pcs, > 20000 pcs 按 0.1%

Note: If the batch volume is no more than 1200pcs, sampling volume is 10pcs; for 1201 ~ 3200pcs, it is 15pcs, for 3201~20000pcs, it is 20pcs, for >20000pcs, it is 0.1%;

6. 型式试验 (Type test)

检验项目 Inspection items	样本量 sample qty	检验工具 Inspection tools	检验标准 Inspection standard	允收标准 Acceptance standard	检验方法 Test method
动作温度 (Tf)	3	硅油池 Silicone oil bath	均应在相应产品的动作温度规格范围内 All should be within the specified Tf temp. of corresponding products	C=0	将产品放入硅油池中, 在起始温度(为额定动作温度-12K)恒温 5 分钟后, 以 0.5K/min - 1K/min 的速率升温, 记录产品熔断时的温度, 检测电流在 10mA 以下 TCO is tested in the oil bath of which the starting temperature(Tf minus 12K) maintains 5 minutes and the temperature rises at 0.5K/min-1K/min (testing current less than 10mA). Record down the temperature when TCO fuses off.
极限温度 (Tm)	3	恒温\绝缘电阻表\高压机 Thermostat \ insulation resistance meter \ high pressure machine	试样无闪络、击穿 绝缘电阻两极>0.2MΩ 绝缘电阻极壳>20MΩ no flashover or breakdown, 2 poles of insulation resistance >0.2MΩ insulation resistance of pole shell >20MΩ	C=0	恒温箱温度控制在 Tm+0/-5℃, 试样放入后在此温度保持 10 分钟, 随后做绝缘及耐压试验, 试验结束后, 试样应无闪络, 击穿或重新接通 Thermostat temperature control at Tm+0/-5℃, put the sample inside for 10 min, then conduct tests of insulation and voltage withstand. After the testing, check and make sure there is no flashover, breakdown or re-conduction.
保持温度 (Th)	3	恒温箱\电子负载仪 Thermostat \ electronic load meter	加载额定电流、持续进行 168 小时, 其产品不能断开 Load with rated current for continuous 168 hours, the product not disconnected	C=0	试样放入恒温箱内, 使恒温箱温度保持在 Th+0/-6℃ 的范围内稳定, 测温仪的热电偶贴在温度保险丝外壳表面, 通过额定电流, 持续进行 168 小时, 判断其是否会断路 Sample put in the thermostat and maintain temperature at Th+0 / 6 °C. Attach thermocouple to the surface of product shell, loaded with rated current for continuous 168 hours and check it is connected
老化 Aging	15	恒温箱 Thermostat	最后阶段, 试样全部断开 all samples disconnected in the final stage	C=0	第一阶段: 样品在 Tf-15K 下放置 3 周, 试验结束时至少 50% 以上试样未动作; 第二阶段: 样品在 Tf-10K 下放置 2 周; 第三阶段: 样品在 Tf-5K 下放置 1 周; 第四阶段: 样品在 Tf-3K 下放置 1 周; 第五阶段: 样品在 Tf+3K 下放置 24 小时; 1st stage: samples stored condition of Tf-15K for 3 weeks, at the end of testing, at least 50% samples not fuse off; 2nd stage: samples stored in condition of Tf-10K for 2 weeks; 3rd stage: samples stored in condition of Tf-5K for 1 week; 4th stage: samples stored in Tf-3K for 1 week; 5th stage: samples stored in Tf+3K for 24 hours;

7. 参数说明 (Parameter specifies)

额定动作温度 Rated functioning temperature (Tf)	温度保险丝按安全标准规定方法测试，改变其导电状态的温度。按基于 IEC60691 的安规标准规定，温度保险丝必须在上述温度+0/-10℃范围内动作。简称 Tf。 The temperature at which a Thermal Cutoff changes its state of conductivity to open circuit detection current. The tolerance according to IEC60691 is form +0 to -10 °C .
实际动作温度 Fusing-off temperature	温度保险丝在硅油池内以每分钟 0.5 – 1.0K 速率升温，检测电流小于 10mA 条件下所测得的熔断温度。它是温度保险丝的实际动作温度。 The Fusing-off temperature indicates valun measured in silicon oil with a temperature increased by 0.5-1K per minute and a detective current 10mA or less.
保持温度 Holding temperature (Th)	温度保险丝在通过额定电流时，能保持 168 小时而不会改变其导电状态的最高温度.用 Th 表示。 The maximum temperature at which a Thermal Cutoff will not cause a change in state of conductivity to open circuit while conduction rated current for 168H .This rating is required by safety standards based on IEC60691.
极限温度 Maximum temperature limit (Tm)	温度保险丝能承受 10 分钟而不会发生重新接通现象的最高温度。简称为 Tm。 The maximum temperature at which a Thermal Cutoff can be maintained for 10 minutes without reclosing. This rating is required by safety standards based on IEC60691.
额定电流 Rated current (Ir)	温度保险丝所能承载的最大电流。 The allowable maximum current which a Thermal Cutoff is able it carry.
额定电压 Rated voltage (Ur)	温度保险丝最高工作电压。 The allowable maximum voltage which a Thermal Cutoff is able it carry.

8. 安全认证编号 (Safe Certification Numbers)

产品型号: Model No:	UL/CUL	VDE	CCC	PSE
P0-5A-F	E140847	40000039	2011010205464040	JET0749-32001-1005
P1-5A-F	E140847	40000039	2011010205464040	JET0749-32001-1003
P2-5A-F	E140847	40000039	2011010205464040	JET0749-32001-1003
P3-5A-F	E140847	40000039	2011010205464040	JET0749-32001-1004
P4-5A-F	E140847	40000039	2011010205464040	JET0749-32001-1004
P5-5A-F	E140847	40000039	2011010205464040	JET0749-32001-1004
P9-5A-F	E140847	40000039	2011010205464040	JET0749-32001-1004
P12-1A-F		40000039	2011010205464040	JET0749-32001-1006
P7-5A-F	E140847	40000039	2011010205464040	JET0749-32001-1006

9. 环保 (Environmental)

① 符合 RoHS 环保指令。

Comply with the RoHS environmental directives.

② 符合 SONY SS-00259。

Comply with SONY SS - 00259.

③ 符合 REACH 法规中 SVHC (高关注物质)物质含量的要求。

Comply with REACH regulation SVHC (high attention substance) material content requirements.

10.印刷标志 (Printing marks)

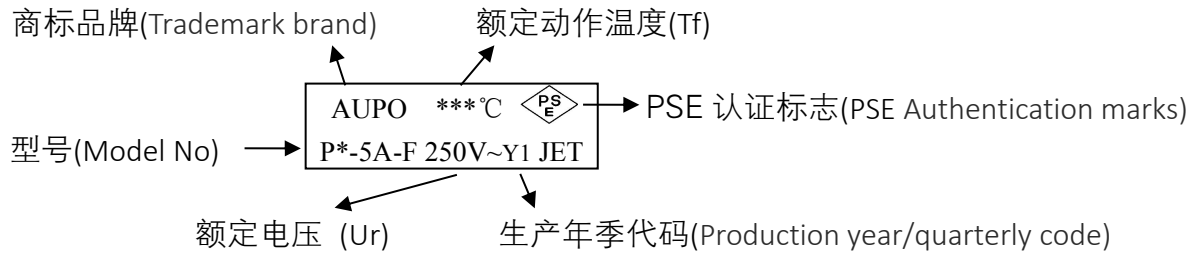

注: (Note)

年的代表方式 Production year code	Y、Z、C、D、E… (除A、B、P、S、T外,按照英文字母顺排) Except for A, B, P, S, T, according to the English letters in series
	11、12、13、14、15…….(Y代表2011年顺序排列对应) Corresponding based on “Y” representative for 2011 year in series
季度的代表方式 Quarterly code	1、2、3、4 代表一年的四季 1、2、3、4 represents a year of four seasons in series)

如: “Y”、“Z”代表 11年、12年。“Y1”、“Y2”代表 11年第一、第二季度;
For example: “Y”, “Z” Representative for 11, 12 years.

“Y1”, “Y2” Representative 11 years first and second quarter .

11.包装 (Packaging)

每 100 只产品为一个小包装单位, 每 10 小包产品为一个大包装单位。

A small package includes 100Pcs. A big package includes 10 small packages. (10×100pcs).

12.小包装标识 (Marking on Package)

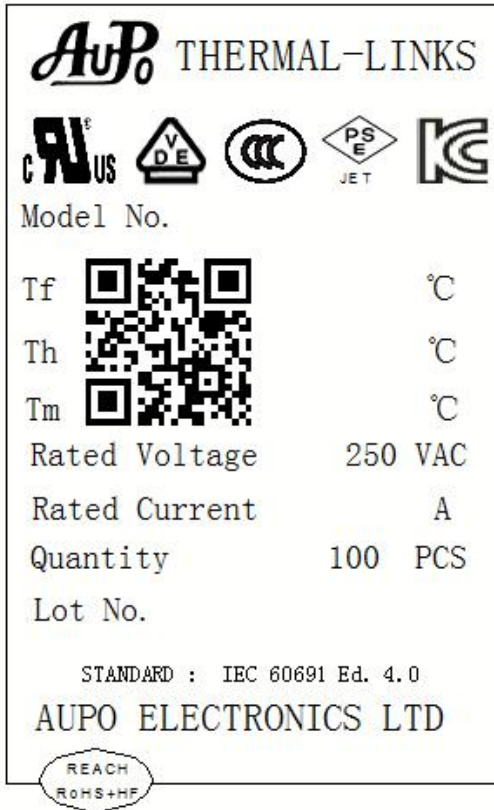

- a、商标 Trademark
- b、REACH ROHS+HF 标志 Mark
- c、品名 Product Name
- d、安规认证标志 Certificate Mark
- e、产品型号 Model No.
- f、额定动作温度 Tf
- g、保持温度 Th
- h、极限温度 Tm
- i、额定电压 Rated Voltage
- j、额定电流 Rated Current
- k、数量 Quantity
- l、批号 Lot No.
- m、安规认证标准 Certificate Standards
- n、制造公司名称 Manufacturer's Name
- o、产品二维码 Product QR code

注：包装袋上认证标志以产品实际通过认证为准，此图仅示意用

13.储存条件和有效期 (Storage Conditions and Preservation period)

温度保险丝的储存条件：清洁、通风、无腐蚀性气体、无硫气体、无阳光直射、温度：5℃~35℃、湿度：25%RH~75%RH、气体：86KPa~106KPa 的环境中；温度保险丝的保存期：贵司入库后 6 个月。

Storage conditions of temperature fuse:clean,ventilated,non-corrosive gas,sulfur-free gas, no direct sunlight,temperature 5℃~35℃,humidity:25%RH~75%RH,air pressure:86KPa~106KPa;Preservation period of temperature fuse:6months after storage.

14. 安装使用注意事项 (Application instruction)

AUPO 合金型温度保险丝安装使用注意事项
Alloy Type Thermal Cutoff Application Instruction



在你设计应用或安装 AUPO 温度保险丝之前请阅读本说明。本说明的目的是为了降低由于应用中不正确的设计、安装方法及危害的工作环境而导致引起的温度保险丝不正常的危险。

Please study these instructions before designing or installing AUPO Thermal Cutoffs (thermal-links). These instructions are provided to reduce the risk of malfunction of thermal cutoffs which may result from improper design, installation methods and harmful operating conditions which may occur during use in the end-product.

- 每一温度保险丝都有其额定的电气及温度参数，应用中应使其工作在规定的额定参数范围内。这些参数包括 Tf (额定动作温度)，Th 或称 Tc (保持温度)，Tm (极限温度) 及额定电流、电压，详情请参见《合金型 1A~25A 系列温度保险丝规格参数表》上每一型号的参数。
- 安装设计时应注意温度保险丝的长期连续工作环境温度不要超过它们的保持温度。
- 温度保险丝是一不可复位的装置，为安全起见，在更换温度保险丝时请选用同一型号的温度保险丝，安装在同一位置上。
- 在设计应用产品时注意让温度保险丝只感受要求的热源。例如：在使用于加热器的状况中，温度保险丝不能直接与电热丝连接，必须通过一不发热的导线与热丝隔离，以使电热丝的热不至于通过引脚传入温度保险丝导致加速它的动作，再如在应用于变压器或电机的例子，温度应控制于其线圈内部因此温度保险丝须与线圈有良好的热传导。
- 应用产品必须经过测试以确定出现任何异常状况时都不会使温度保险丝周围温度超过极限温度 (Tm)，这种状况可能出现在一种称为“余热过冲”的状况下。例如：一个热风机在进风口或出风口堵塞时引起温度升高到 Tf，这时温度保险丝断开电路，但是，一个不正确的设计可能会引起装置提前开路和过度的余热过冲可能会损伤保险丝，应用产品须经测试以确定在正常的温度波动状态 (如控温器的动作与复位引起的加热器温度波动) 下，温度保险丝周围温度在控温器的通断循环中不会达到 Tm。(见图 1)
- 在设计时建议用一个内装有热电偶温度保险丝的模式来选择确定适当的额定温度规格及安装位置。
- 不要将温度保险丝安装于剧烈震动的场合。
- 温度保险丝可使用锡焊、点焊、绞接的方式连接。
- 当弯曲引脚时，须用工具操作以确保引脚弯曲有足够弧度，引脚不可在距离根部 L2 内弯曲，在弯曲时工具不可夹着外壳及封口树脂。(见图 2)
- Each thermal cutoff has specific Electrical and Temperature Rating and must be used within the prescribed ratings. These ratings include Tf (Rated Functioning Temperature), Th or Tc (Holding Temperature), Tm (Maximum Temperature Limit), and the electrical ratings. Please refer to the AUPO THERMAL CUTOFFS Catalogue for specific ratings and further explanation of these terms.
- Install thermal cutoffs so that their temperature do not continuously exceed the Holding Temperature specified in the individual specification.
- For reason of safety that a thermal cutoff is a non-repairable item and that in case of replacement, an equivalent thermal cutoff with the same catalogue number shall be used, mounted in exactly the same way.
- The end product should be designed so that the thermal cutoff detects only the intended heat source (radiant, convection, and/or conduction). For example, in a heater wire and should be isolated to the heater wire by a cold pin so that conduction through the lead wire does not accelerate the fusing off of the thermal cutoff, in case of a transformer of motor application, the thermal cutoff should have good heat conductive contact with the transformer or motor coil.
- The end product should be tested to ensure that potentially abnormal conditions do not expose the thermal cutoff to the temperature exceeding its Tm. This condition may be subjected to a blocked inlet or outlet condition on attaining its Rated functioning temperature opening of the device and excess overshoot may cause shooting or damage to the thermal cutoff. The end product should be tested to ensure that under normal cycling condition (such as cycling of a thermostat), the thermal cutoff never reaches its Tf during the on/off cycle. (see Fig 1)
- It is recommended that using the dummy thermal cutoff having an internal thermocouple to select the proper temperature rating and location of the thermal cutoff.
- Do not locate the thermal cutoff on an assembly subjected to severe continuous vibration.
- The thermal cutoff can be connected by soldering, welding or splicing.
- When forming leads, a tool should be used to ensure that the leads are formed with sufficient curve. Leads should not be bent closer than L1 to the thermal cutoff body. Holders or tools used during lead forming must be kept away from seal or body. (see Fig2)



图 1 Fig.1



图 2 Fig.2

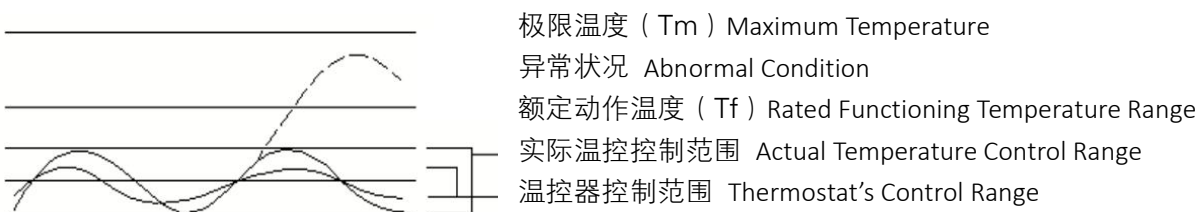

引线弯折 Lead wire bending

Φ (mm)	<1.0	1.0~1.6
L2 (mm)	>3	>7

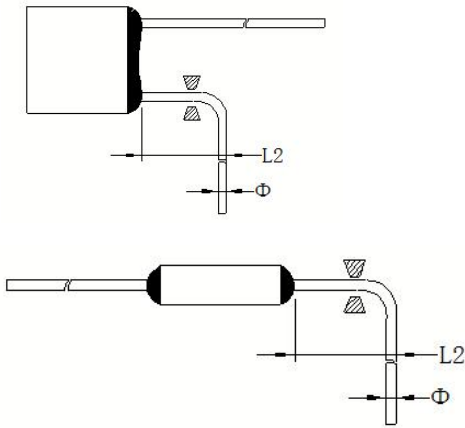
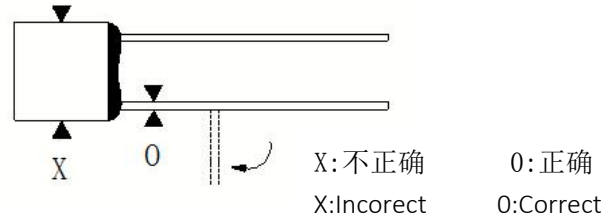
- 引脚在安装时不可被损伤、打缺口、锐利角度弯曲、烧灼。
- Leads should not be cut,nicked,folded sharply,fractured or burned during forming or installation.
- 封口树脂及外壳不可被损伤/烧灼或过热。
- The seal or body must not be damaged,burned or over heated.
- 不可扭转温度保险丝（例如：引脚相对壳体旋转）。
- Do not twist the thermal cutoff,(i.e.rotation of lead with respect to the body).
- 避免施加一个带角度的力于引脚上（如：相对外壳成一角度推或拉引脚），这样会伤及封口树脂。
- Tangential forces on the leads must be avoided (i.e.pushing or pulling on the leads at angle to the thermal cutoff body) as such forces may damage the thermal cutoffs seal.
- 固定温度保险丝时不要施加过大的压力于壳体、封口树脂或引脚上（如拉引保险丝、夹持过度或捆扎过紧），这样会引起损坏保险丝或引起应力集中在引脚上。
- Securement of the thermal cutoff after making connections should not put excessive pressure on the thermal cutoff body,seal or leads (i.e.pushing the thermal cutoff, excessive clamping or too tight of a wrap) which could result in denting of the thermal cutoff or place pushing or pulling stress on the leads.
- 连接引线应留有足够剩余长度及足够柔软，温度保险丝及绞结点应予固定，以避免在正常使用状态下的震动引起绞结点松动。
- Appropriate free lengths of wire and sufficiently flexible wire connections should be used.The thermal cutoff and splices should be secured to prevent vibration or flexing of the thermal cutoff and splices during normal operation.
- 施加在引脚上轴向力（拉力或推力）绝不可超过规定的试验“拉力”或“推力”，对合金型温度保险丝，最大试验拉力为 1 磅，最大试验力为 0.4 磅（在室温下），必须先做样品试验以确定在生产工序中不会产生超过最大试验“拉力”及“推力”在引脚上。
- Axial stress (pull or push) on the leads must never exceed the maximum tested 'pull' or 'push' force .For A series 'AUPO' thermal cutoffs,maximum tested 'pull' force is 1.5 pound,and maximum tested 'push' force is 0.4 pound,at room temperature. Experimental assembly trials should be made to verify that manufacture procedures will not exceed the maximum tested 'pull'and'push' force on the leads.
- 当设计应用产品时，必须考虑那些与引脚、壳体接触的元素材料的收缩、膨胀及其它移动引起的应力，应使用柔软、可弯曲的或冷、低电阻的引线来与温度保险丝连接。
- Stress due to expansion and contraction of parts attached to the leads or body, vibration or other movements of parts should be considered when designing the end product.A flexible or bent heater lead or a cold,low resistance heater lead should be used to connect to the thermal cutoff.
- 接点电阻必须控制以确保使电阻最低，不适当的连接会导致保险丝提前动作，接点必须抽样检验以确保连接处有合适的机械连接强度，不适当的连接点会导致接点电阻增大进而在接点产生高温，引起损伤封口树脂及其它部件，这可能使装置产生短路或其他故障。
- Resistance of connections should be monitored to ensure minimal resistance. Improper connections or secure may result in premature failure of the thermal cutoff Samples of joints should be inspected to ensure adequate mechanical bonding of lead to connection wires.Improper connections can cause damage to the seal or other parts which may result in shorting or nuisance tripping of the devices due to the generation of excessive heat at a faulty high resistance junction.
- 当使用焊锡点焊时，须注意避免焊接过热损伤温度保险丝。表一为最长焊接时间指南，因为温度保险丝内部感温元件为一段低熔点合金丝，连接在两引脚上，不恰当的焊接作业（焊接温度过高，焊接时间太长，引脚过短等）会使热量通过引脚传入温度保险丝内部，使感温元件过热受损（熔断，或末端受热冲击变细），从而变脆弱，与引脚连接可靠性降低，当使用电流通过或其他原因，受损部位就可能产生早断现象。
- When soldering or welding,take caution to minimize the conduction of excessive heat to the body of thermal cutoff.Table 1 is provided as a guide to maximum soldering time because the thermal element of thermal cutoff is a fusible alloy which connected with lead wires.improper soldering operation (too high the soldering temperature,too long the soldering time,too short the lead wire used etc.) will cause thermal element injured by the excessive heat transmit from the lead wire which may result in premature opening of the thermal cutoff.

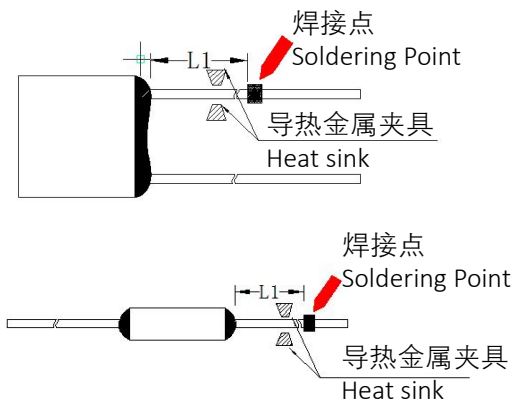

额定动作温度 Tf	焊接高度及允许的最大焊接时间 Max time limit for soldering at different heights			焊接温度 Soldering temperature
	L1=10mm	L1=20mm	L1=30mm	
< 115°C	1S	2S	3S	400°C
115°C~134°C	2S	3S	4S	
135°C~150°C	3S	4S	5S	
> 150°C	4S	5S	6S	

表一 Table 1

避免焊接过热损伤温度保险丝方法

- 尽可能利用长一些的引脚，长一些的引脚允许较长的焊接时间及减少过热的可能性（见图 3）为如何在较小的位置保留长一些的引脚例子。在引脚较短的情况下，在焊接时要用尖嘴钳或其他工具夹在引脚上焊点和保险丝体之间位置上以散热，避免焊接量传入温度保险丝内部。同时焊接温度应控制不要过高，焊接时间尽可能短。
 - 当焊锡或点焊时，引脚必须被适当地固定住，不然引脚或封口树脂可能会被损伤，当封口树脂处于热的时候，拉或扭转引脚可能会使它它与保险丝脱开，引起机械失效。因此，在封口树脂冷却前不要移动保险丝，至少间隔 30 秒方可再次焊接、包扎、固定或移动温度保险丝，冷却时间取决于焊接温度、焊接（或点焊）时间，引脚步长度等，建议先作试验来确定最佳焊接（点焊）时间，温度及何种降温工具。
 - 点焊时电流不可流过感温合金。
 - 机械连接不能单靠钎焊一种。
 - 进货须做检验，看是否在运输过程中产生损坏，建议在安装再次检验，建议在安装前后进行导电测量或 X 射线检验。
 - 原型试样或生产初期抽样及实验装配试验品必须做试验，在正常工作及异常状态下测量产品里的温度保险丝及关键部位的温度，在试验后须检查温度保险丝产品。
- Using the lead wires as long as possible' when soldering, longer leads permit a longer soldering time and reduce the possibility of overheating. Fig.3 is an example of how to keep longer lead wires when a thermal cutoff is installed in a small space. It is recommend that using a heat sink between the soldering point and sealant to minimized the heat transmission to thermal cutoff. Avoid the soldering temperature is too high and keep the soldering time as short as possible.
 - During the soldering or welding, leads should be supported properly, otherwise, the leads or seal may be damaged. pulling or twisting of the lead wires while sealant is hot may cause it to separate from the body and/or leads which can cause mechanical failure. therefore, do not twist the thermal cutoff after soldering or welding until the sealant has cooled. wait at least thirty seconds before re-soldering, taping, securing or reposition test to determine the best soldering (or welding) time, temperature, soldering (or welding) time, lead length etc. it is recommended that you run test to determine the best soldering (or welding) time, temperature that heat sinking on the product.
 - Electrical current must not pass through element when welding.
 - Mechanical security must not depend on solder along.
 - Incoming shipments should be examined for evidence of damage during transportation. it is recommended that further examination be made after installation in the product. conductance measurements or X-raying before and after installation are recommended.
 - Prototype or early production samples and also experimental assembly trials should be operated under normal and abnormal condition with temperature should be operated under normal and abnormal condition with temperature measured on the thermal cutoff and on critical parts of the appliance or ther end product. after the test the thermal cutoff and appliance should be examined.

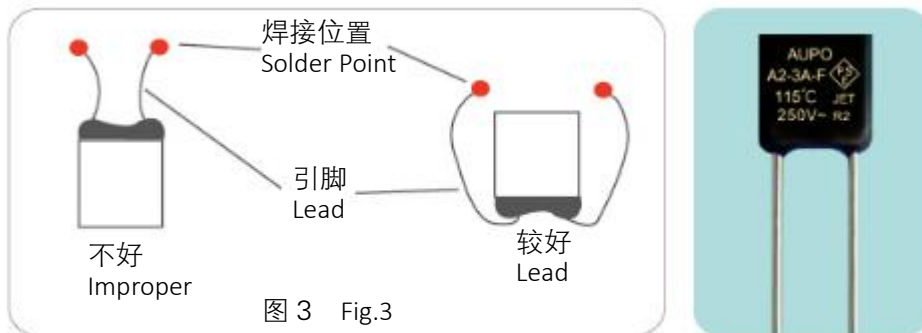

图 3 Fig.3

15. 零件承认书的有效性 (Validity of Specification Sheet)

本承认书提出后，若经过 1 个月后贵公司无异议或无签回承认本时，则默认贵司同意我司承认书内容，承认书有效；若贵司对承认书内容有异议，请及时提出，由两公司协议后再行修订，并重新发出，原承认书作废。

The specifications can be used temporarily during the period of approval. If you have no any objection or not return one hardcopy to us within one month, this specifications will be operated as a valid document. If the content of this specifications is inadequate or need revising, it will be revised after both parties is agreement.